

TLP512

- Digital Logic Ground Isolation
- Line Receiver
- Microprocessor System Interfaces
- Switching Power Supply Feedback Control
- Transistor Inverter

The TLP512 consists of a GaAlAs high-output light emitting diode and a high-speed detector that contains a PN photodiode and an amplifier transistor into a single chip.

- Isolation voltage: 2500 Vrms (min)
- Switching speed: $t_{pHL} = 0.8 \mu s$, $t_{pLH} = 0.8 \mu s$ (max)
@ $R_L = 1.9 k\Omega$
- TTL compatible
- UL recognized: UL1577, file No. E67349

Unit: mm

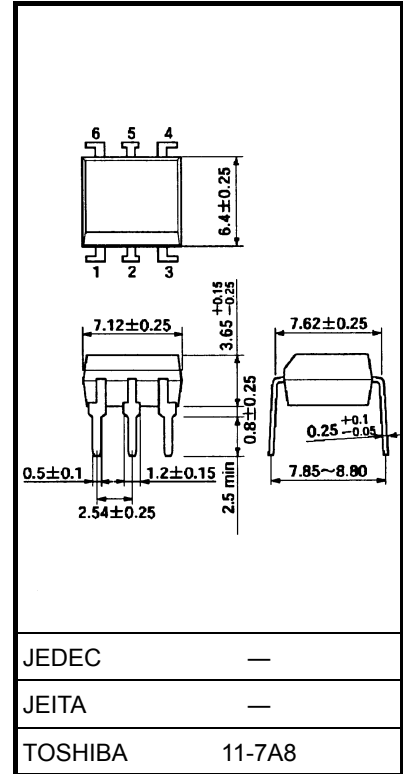

Weight: 0.4 g (typ.)

Pin Configuration (top view)

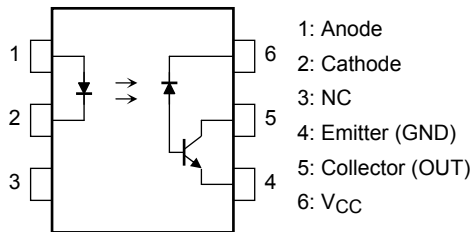

Schematic

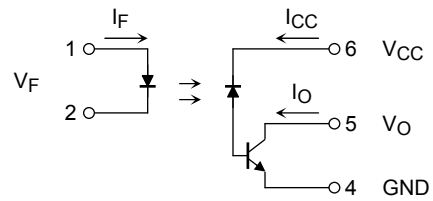

Absolute Maximum Ratings (Ta = 25°C)

Characteristics		Symbol	Rating	Unit
LED	DC forward current (Note 1)	I _F	25	mA
	Pulse forward current (Note 2)	I _{FP}	50	mA
	Peak transient forward current (Note 3)	I _{FPT}	1	A
	DC reverse voltage	V _R	5	V
	Diode power dissipation (Note 4)	P _D	45	mW
Detector	Output current	I _O	8	mA
	Peak output current	I _{OP}	16	mA
	Output voltage	V _O	-0.5 to 15	V
	Supply voltage	V _{CC}	-0.5 to 15	V
	Output power dissipation (Note 5)	P _O	100	mW
Operating temperature range		T _{opr}	-55 to 100	°C
Storage temperature range		T _{stg}	-55 to 125	°C
Soldering temperature (10 s) (Note 6)		T _{sol}	260	°C
Isolation voltage (R.H. ≤ 60%, AC 1 min) (Note 7)		BV _S	2500	V _{rms}

Note: Using continuously under heavy loads (e.g. the application of high temperature/current/voltage and the significant change in temperature, etc.) may cause this product to decrease in the reliability significantly even if the operating conditions (i.e. operating temperature/current/voltage, etc.) are within the absolute maximum ratings.

Please design the appropriate reliability upon reviewing the Toshiba Semiconductor Reliability Handbook ("Handling Precautions"/"Derating Concept and Methods") and individual reliability data (i.e. reliability test report and estimated failure rate, etc).

Note 1: Decreases at the rate of 0.8 mA/°C with the ambient temperature of 70°C or higher.

Note 2: Duty cycle of 50%, pulse width of 1 ms.

Decreases at the rate of 1.6 mA/°C with the ambient temperature of 70°C or higher.

Note 3: Pulse width ≤ 1 μs, 300 pps

Note 4: Decreases at the rate of 0.9 mW/°C with the ambient temperature of 70°C or higher.

Note 5: Decreases at the rate of 2 mW/°C with the ambient temperature of 70°C or higher.

Note 6: Soldering is performed 2 mm from the bottom of the package.

Note 7: Device considered a two-terminal device: pins 1, 2, and 3 shorted together and pins 4, 5 and 6 shorted together.

Electrical Characteristics (Ta = 25°C)

Characteristic		Symbol	Test Condition	Min	Typ.	Max	Unit
LED	Forward voltage	V_F	$I_F = 16 \text{ mA}$	—	1.65	1.85	V
	Forward voltage temperature coefficient	$\Delta V_F / \Delta T_a$	$I_F = 16 \text{ mA}$	—	-2	—	mV/°C
	Reverse current	I_R	$V_R = 5 \text{ V}$	—	—	10	μA
	Pin-to-pin capacitance	C_T	$V_F = 0, f = 1 \text{ MHz}$	—	4.5	—	pF
Detector	High-level output current	$I_{OH(1)}$	$I_F = 0 \text{ mA}, V_{CC} = V_O = 5.5 \text{ V}$	—	3	500	nA
		$I_{OH(2)}$	$I_F = 0 \text{ mA}, V_{CC} = V_O = 15 \text{ V}$	—	—	5	μA
		I_{OH}	$I_F = 0 \text{ mA}, V_{CC} = V_O = 15 \text{ V}$ $T_a = 70^\circ\text{C}$	—	—	50	
	High-level supply current	I_{CCH}	$I_F = 0 \text{ mA}, V_{CC} = 15 \text{ V}$	—	0.01	1	μA

Coupled Electrical Characteristics (Ta = 25°C)

Characteristic	Symbol	Test Condition	Min	Typ.	Max	Unit
Current transfer ratio	I_O / I_F	$I_F = 16 \text{ mA}, V_{CC} = 4.5 \text{ V}$ $V_O = 0.4 \text{ V}$	20	40	—	%
		$I_F = 16 \text{ mA}, V_{CC} = 4.5 \text{ V}$ $V_O = 0.4 \text{ V}, T_a = 0 \text{ to } 70^\circ\text{C}$	15	—	—	
Low-level output voltage	V_{OL}	$I_F = 16 \text{ mA}, V_{CC} = 4.5 \text{ V}$ $I_O = 2.4 \text{ mA}$	—	—	0.4	V

Isolation Characteristics (Ta = 25°C)

Characteristic	Symbol	Test Condition	Min	Typ.	Max	Unit
Capacitance input to output	C_S	$V_S = 0, f = 1 \text{ MHz}$ (Note 7)	—	0.8	—	pF
Isolation resistance	R_S	R.H. $\leq 60\%$, $V_S = 500 \text{ V}$ (Note 7)	5×10^{10}	10^{14}	—	Ω
Isolation voltage	BV_S	AC 1 min	2500	—	—	Vrms
		AC 1 s, in oil	—	5000	—	
		DC 1 min, in oil	—	5000	—	Vdc

Switching Characteristics (Ta = 25°C)

Characteristics	Symbol	Test Circuit	Test Condition	Min	Typ.	Max	Unit
Propagation delay time (H → L)	t_{pHL}	1	$I_F = 0 \rightarrow 16 \text{ mA}, R_L = 1.9 \text{ k}\Omega$	—	—	0.8	μs
Propagation delay time (L → H)	t_{pLH}		$I_F = 16 \rightarrow 0 \text{ mA}, R_L = 1.9 \text{ k}\Omega$	—	—	0.8	μs
Common mode transient immunity at logic high output (Note 8)	CM_H	2	$I_F = 0 \text{ mA}, V_{CM} = 200 \text{ V}_{P-P}$ $R_L = 1.9 \text{ k}\Omega$	—	1500	—	$\text{V}/\mu\text{s}$
Common mode transient immunity at logic low output (Note 8)	CM_L		$I_F = 16 \text{ mA}, V_{CM} = 200 \text{ V}_{P-P}$ $R_L = 1.9 \text{ k}\Omega$	—	-1500	—	$\text{V}/\mu\text{s}$

Note 8: Common mode transient immunity in logic high level is the maximum tolerable (positive) dV_{CM}/dt on the leading edge of the common mode pulse, V_{CM} , to assure that the output will remain in a logic high state ($V_{OUT} > 2.0 \text{ V}$).
Common mode transient immunity in logic low level is the maximum tolerable (negative) dV_{CM}/dt on the trailing edge of the common mode pulse, V_{CM} , to assure that the output will remain in a logic low state ($V_{OUT} < 0.8 \text{ V}$).

Note 9: Electrostatic discharge immunity (pin to pin): 100 V (max)
($C \leq 200 \text{ pF}, R = 0$)

Test Circuit 1: Switching Time Test Circuit

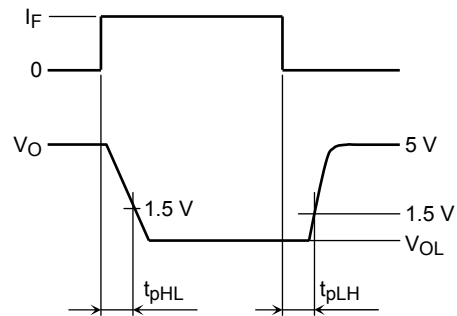
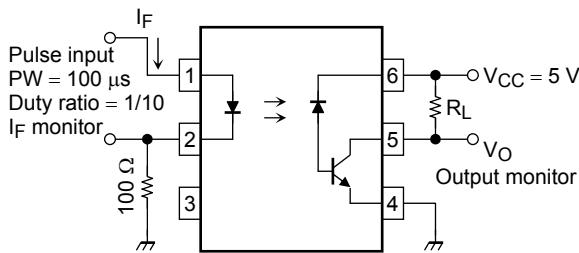

Test Circuit 2: Common Mode Noise Immunity Test Circuit

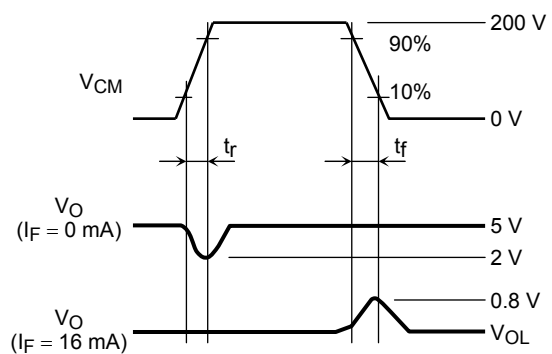
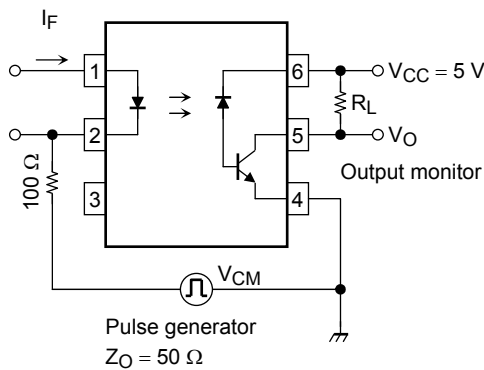

$$CM_H = \frac{160 \text{ (V)}}{t_r \text{ (\mu s)}}, CM_L = \frac{160 \text{ (V)}}{t_f \text{ (\mu s)}}$$

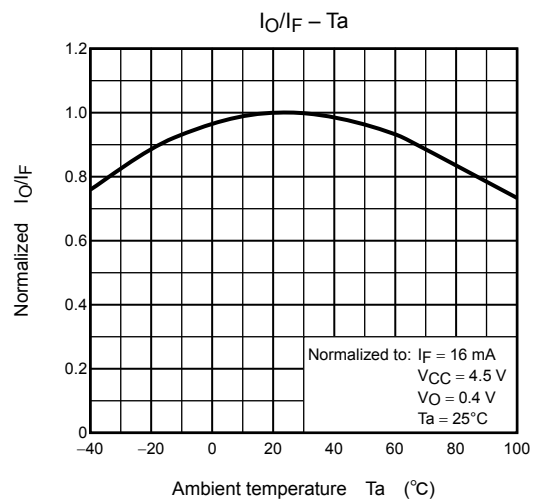
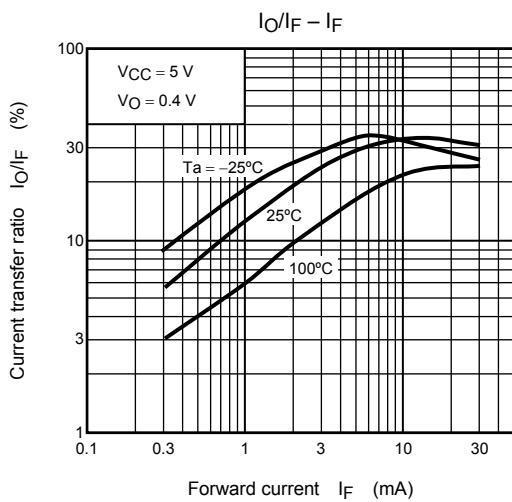
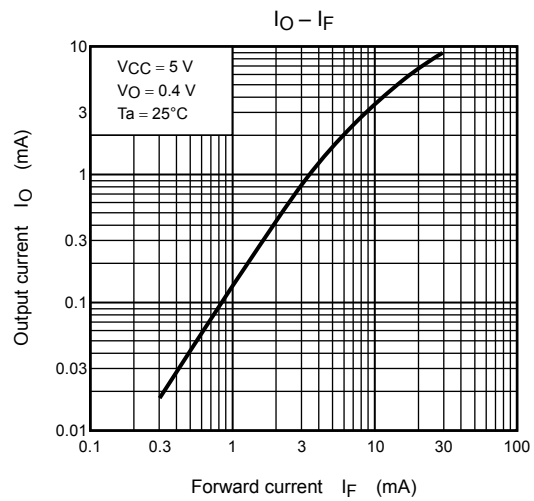
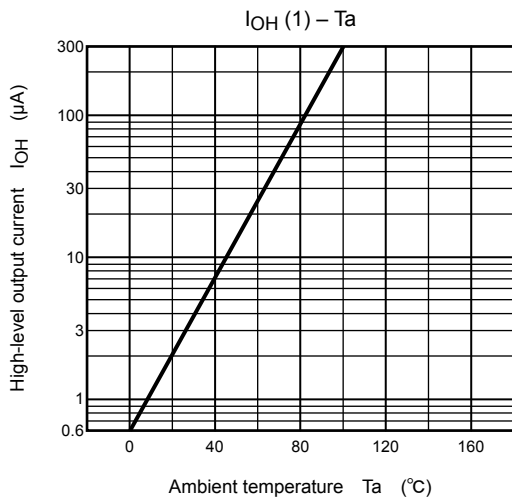
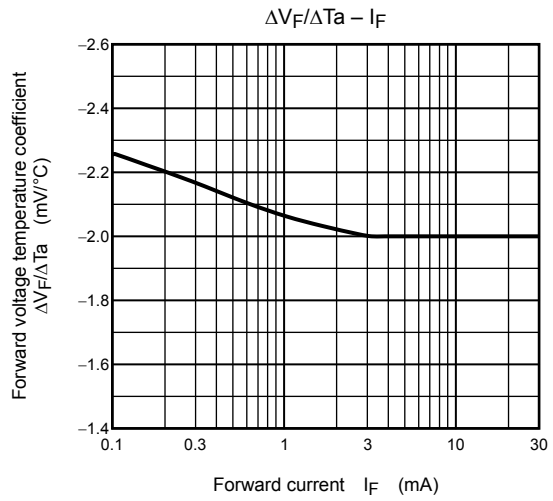
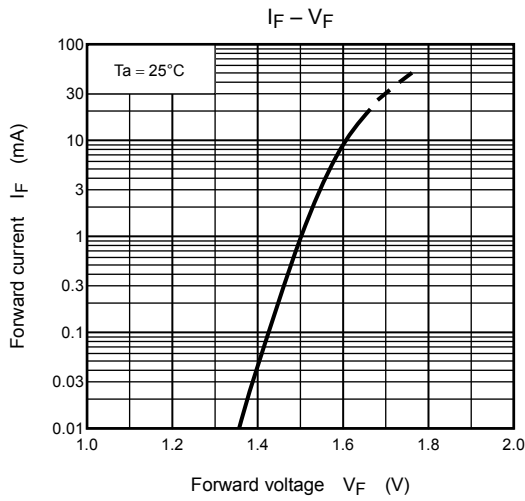

*: The above graphs show typical characteristics.

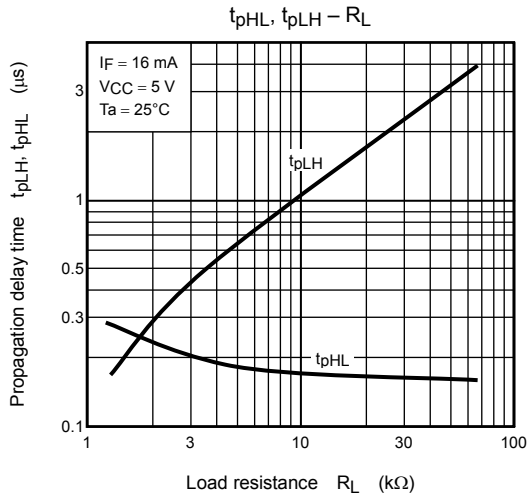
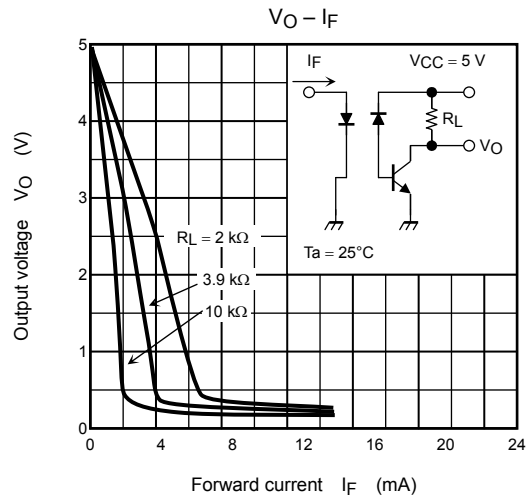
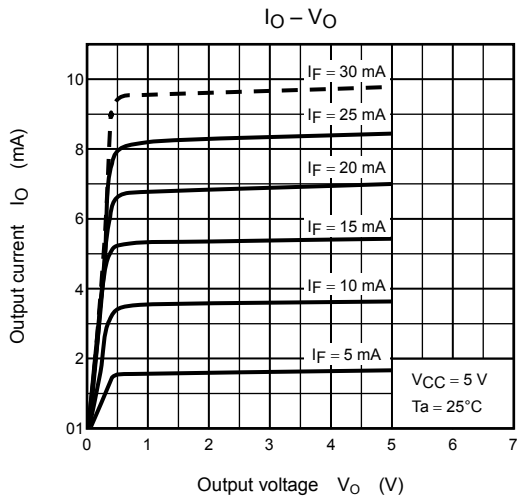

*: The above graphs show typical characteristics.

RESTRICTIONS ON PRODUCT USE

20070701-EN

- The information contained herein is subject to change without notice.
- TOSHIBA is continually working to improve the quality and reliability of its products. Nevertheless, semiconductor devices in general can malfunction or fail due to their inherent electrical sensitivity and vulnerability to physical stress. It is the responsibility of the buyer, when utilizing TOSHIBA products, to comply with the standards of safety in making a safe design for the entire system, and to avoid situations in which a malfunction or failure of such TOSHIBA products could cause loss of human life, bodily injury or damage to property.
In developing your designs, please ensure that TOSHIBA products are used within specified operating ranges as set forth in the most recent TOSHIBA products specifications. Also, please keep in mind the precautions and conditions set forth in the "Handling Guide for Semiconductor Devices," or "TOSHIBA Semiconductor Reliability Handbook" etc.
- The TOSHIBA products listed in this document are intended for usage in general electronics applications (computer, personal equipment, office equipment, measuring equipment, industrial robotics, domestic appliances, etc.). These TOSHIBA products are neither intended nor warranted for usage in equipment that requires extraordinarily high quality and/or reliability or a malfunction or failure of which may cause loss of human life or bodily injury ("Unintended Usage"). Unintended Usage include atomic energy control instruments, airplane or spaceship instruments, transportation instruments, traffic signal instruments, combustion control instruments, medical instruments, all types of safety devices, etc.. Unintended Usage of TOSHIBA products listed in this document shall be made at the customer's own risk.
- The products described in this document shall not be used or embedded to any downstream products of which manufacture, use and/or sale are prohibited under any applicable laws and regulations.
- The information contained herein is presented only as a guide for the applications of our products. No responsibility is assumed by TOSHIBA for any infringements of patents or other rights of the third parties which may result from its use. No license is granted by implication or otherwise under any patents or other rights of TOSHIBA or the third parties.
- GaAs(Gallium Arsenide) is used in this product. The dust or vapor is harmful to the human body. Do not break, cut, crush or dissolve chemically.
- Please contact your sales representative for product-by-product details in this document regarding RoHS compatibility. Please use these products in this document in compliance with all applicable laws and regulations that regulate the inclusion or use of controlled substances. Toshiba assumes no liability for damage or losses occurring as a result of noncompliance with applicable laws and regulations.